

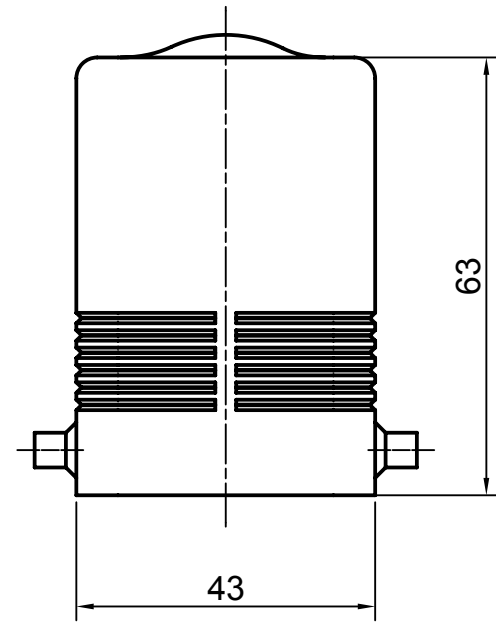

Diritti riservati

All rights reserved

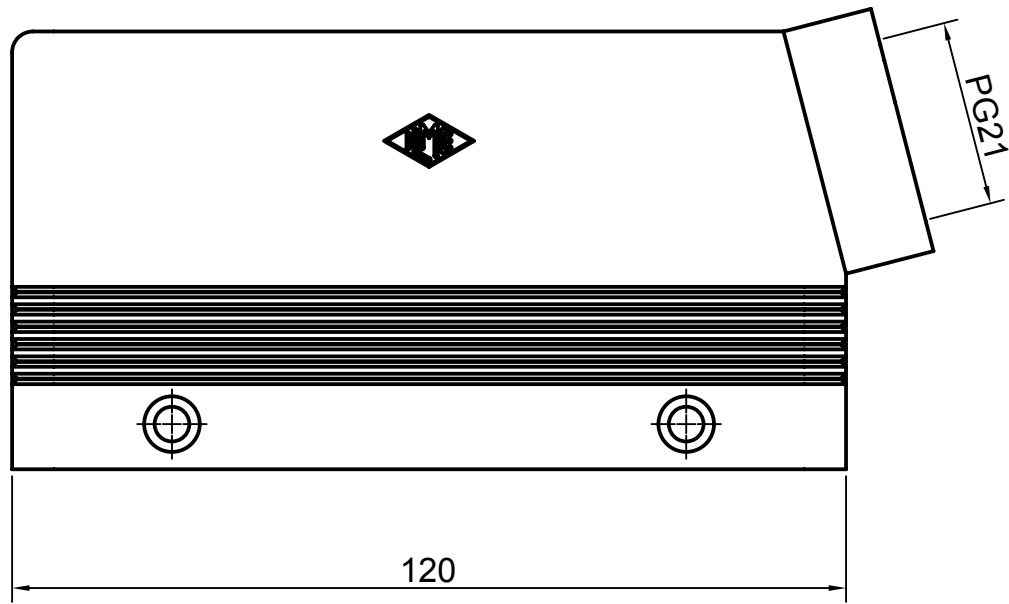

Date 10.01.2007	CMO 16	Scale	
Sign.	hood side entry PG21 ins.	1:1	